



REPUBLIC OF TURKIYE
MINISTRY OF NATIONAL EDUCATION
The General Directorate
of Technical and Vocational Education

15th INTERNATIONAL MoNE ROBOT CONTEST

AUTONOMOUS VEHICLE CATEGORY RULES





RULES

1. Objective

The autonomous vehicel category is an autonomous robotics competition based on image processing. This competition is designed to improve programming skills, to follow the developng technology, to provide the vision to use the gains obtained in other fields and to make the process fun. Autonomous robots in this category stay on the competition track and work to perform the desired tasks and complete the track as soon as possible

2. Track details

- The track is made of 100 cm wide, 18 mm thick, raw chipboard painted black. There will be dashed and straight road lines in white on the black background.
- Parkour road edges will be covered with 10 cm yellow coloured elevation.
- There will be coloured lights 1 metre ahead of the starting line and at a height of 30 cm. The start of the competition will be by means of these lights.
- There will be a sensor placed at a height of 5 cm at the starting line, which will start the stopwatch to measure the competition time.
- There will be 4 different tasks to be performed by the autonomous robot along the track. These tasks will be school pedestrian crossing, level crossing, vehicle overtaking and parking. There will be 20 cm high signs on the roadside for pedestrian crossing, level crossing and overtaking.
- The location of the level crossing and pedestrian crossing tasks will not be announced until the day of the competition.
- In order to fulfil the vehicle overtaking task, 1 vehicle will be used. The vehicle can be placed in any position where there is no overtaking ban. Sample locations where the vehicle can be placed are shown in Figure 1. (Colour of the overtaking vehicle: Orange, size of the overtaking vehicle: 20x30 cm)
- At the end of the track, there will be 3 parking areas of 28x40 cm with different ground colours. The robot will be asked to park in the white coloured area.
- There will be a sensor 5 cm above the ground in the parking area that will stop the stopwatch to measure the competition time.

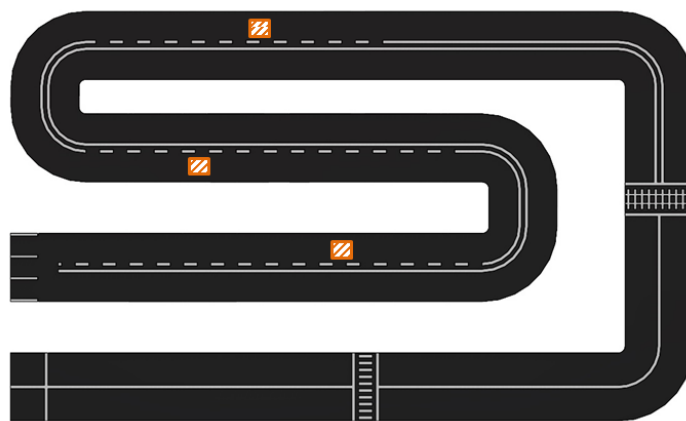

Figure 1. Competition track

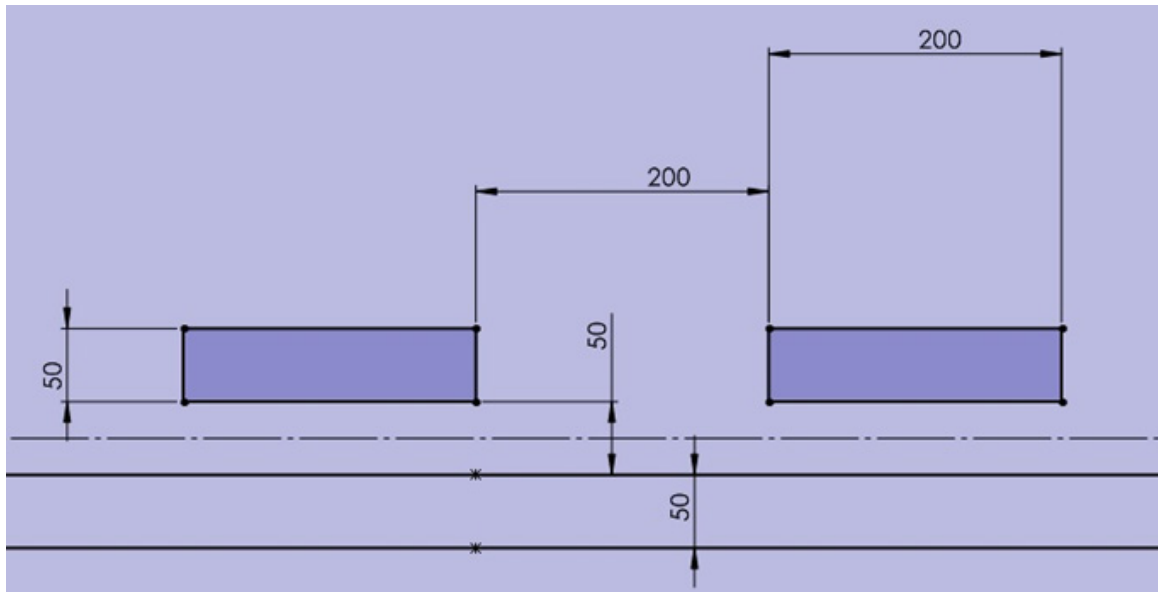

Figure 2. Road line dimensions

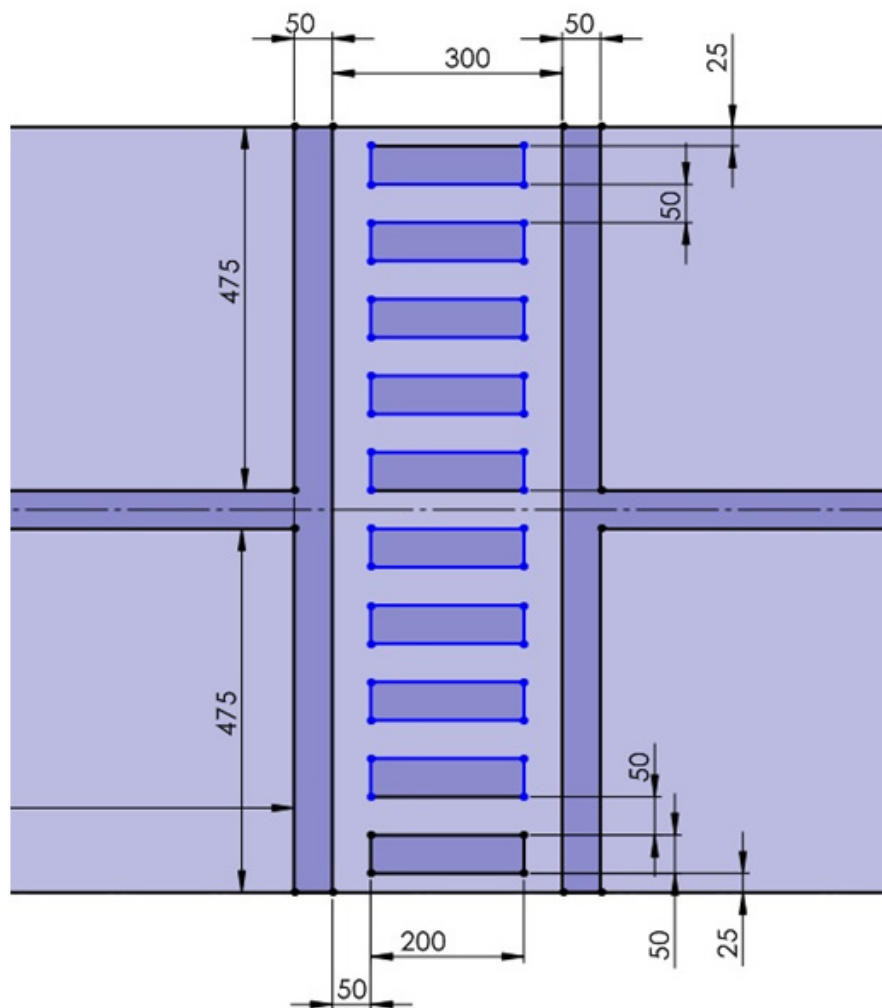

Figure 3. Pedestrian crossing dimensions

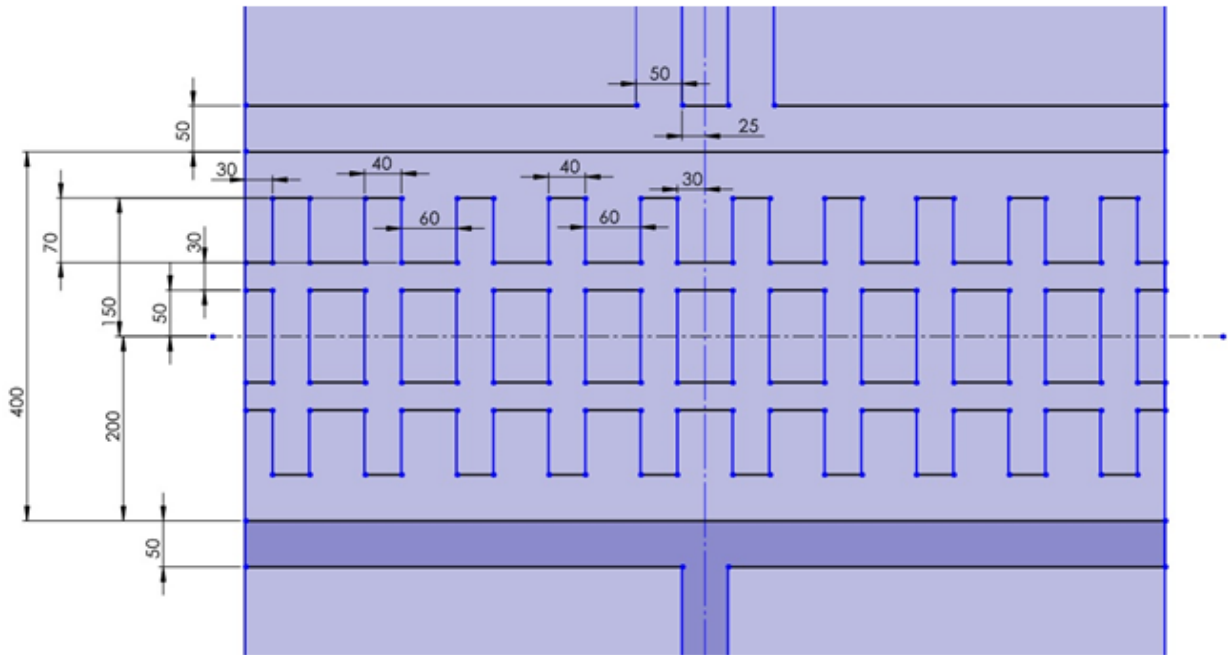

Figure 4. Level crossing dimensions

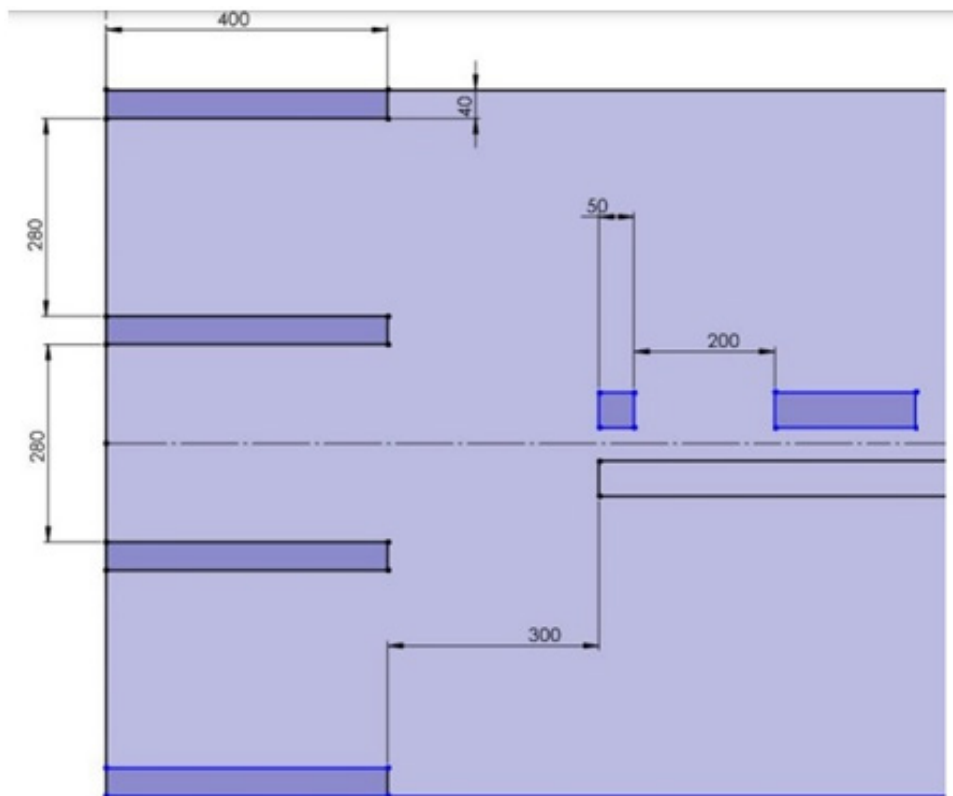

Figure 5. Park area dimensions

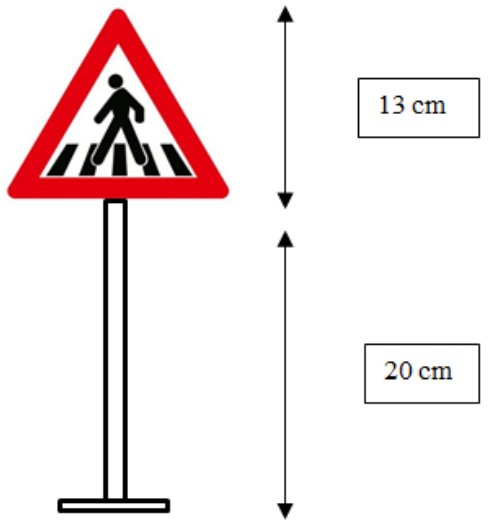

Figure 6. Pedestrian crossing signage dimensions

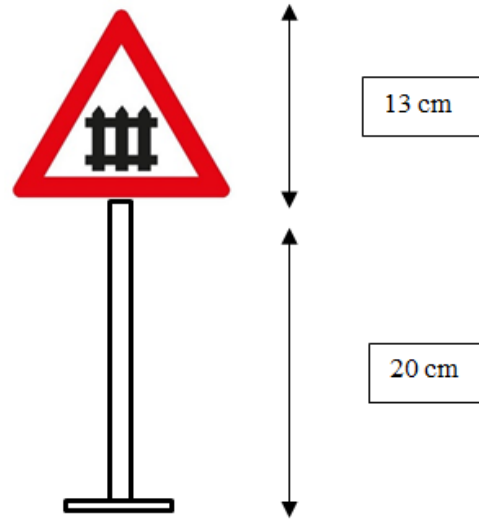

Figure 7. Level crossing signage dimensions

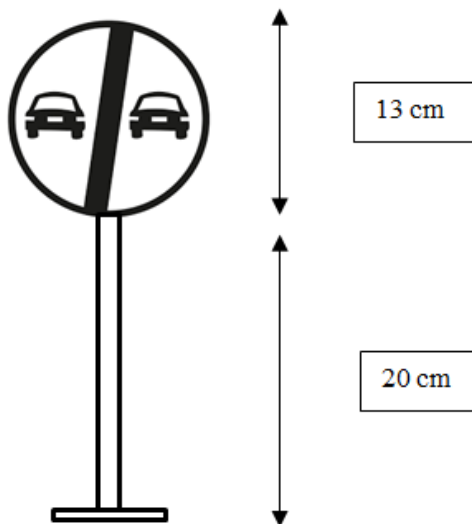

Figure 8. Overtaking sign dimensions

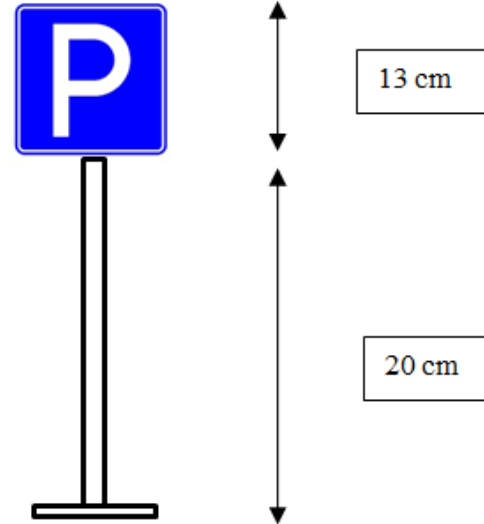

Figure 8. Parking lot signage dimensions

3. Robot Specification

In order for robots to compete in this category:

- Robots must fit comfortably in a 20x30 cm box.
- The height of the robots cannot exceed 25 cm. There is no weight limit for robots.
- Robots that do not fit in a 20x30 cm box or exceed 25 cm in height are disqualified.
- The wheel diameter to be used must not exceed 10 cm.
- Since the competition is based on image processing, no other sensor or sensor-like electronic or mechanical device other than a camera may be used.
- There is no limit to the number of cameras to be used.



- There will be no infrared, bluetooth, radio signals, wifi, etc. electronic devices that provide remote control on the robots. If detected, the competitor will be disqualified.
- There is no limitation on the controller or control card to be used.
- Likewise, there is no limitation for the number of engines and the number of revolutions of the engines to be used.

4. Competition

4.1. Application stage

- For the autonomous robot category, a preparation report will be requested for robots applying to the competition via <https://robot.meb.gov.tr>.
- The applications of the competitors who do not send the detailed report until 17.02.2023 will not be accepted.
- On 20.02.2023, the list of robots whose applications are accepted will be announced in the announcements section of <https://robot.meb.gov.tr>.

4.2. Test stage

- Autonomous robots will be allowed to test on the track on the first day according to the number of competitors whose applications are accepted.
- The decision whether or not to hold the test phase and the format of the competition will be announced on 20.02.2023 in the announcements section of <https://robot.meb.gov.tr>.
- Each team will be given equal time during the test phase.
- Robots that damage the track during the test phase or during the competition will be disqualified.

4.3. Ranking Competition

- The competition starts when the robots cross the starting line and ends when they pass the sensor in the parking area.
- The robots taken to the competition area are placed behind the starting line and made operational by the competitor.
- The lights in the starting section will turn green before the start of the competition; when this colour first turns red and then green again, the robots will start the competition.
- Robots that cannot start will be given 5 minutes for technical intervention, provided that they stay in the field, and then they will be asked to start again. The robot that fails to start for the second time will be disqualified.
- Robots will stop at the pedestrian crossing. The distance between where the robot stops and the pedestrian crossing should be maximum 30 cm. It must wait here for at least 5 seconds. Robots that fulfil this task will receive 25 reward points.
- Robots will stop at the level crossing. The distance between where the robot stops and the level crossing must be maximum 30 cm. It must wait here for at least 5 seconds. Robots that fulfil this task will receive 25 reward points.



- Robots must move to the right lane in the area where overtaking is prohibited and fulfil the overtaking task when the prohibition ends. Robots that fulfil this task will receive 25 reward points.
- There will be 3 parking areas at the end of the track. These parking areas will be red, blue and white. The robot will park in the white coloured area. Robots that fulfil this task will receive 25 reward points.
- If the autonomous robots hit the walls, 5 penalty points will be given for each impact, and 15 penalty points will be given if they hit the overtaking vehicle.
- If the autonomous robot moves by continuously touching the wall, it will be disqualified.
- The maximum completion time of the competition is 10 minutes.
- When the robot enters the parking area at the end of the track, the stopwatch will stop and the robot's competition time will be determined.
- At the end of the ranking competitions, the ranking is made with the total points of the robots finishing the competition.
- Total score= [reward points-penalty points].
- In case of equality, robots are ranked according to the time to finish the competition.
- The robot with the lowest time in the ranking is declared first.
- The format of the competition will be determined according to the number of competitors whose applications are accepted. Format information will be announced on 20.02.2023 from the announcements section of <https://robot.meb.gov.tr>.

5. Other Rules

Competitors called to the track are not given additional time to charge their batteries.

- - No permanent trace or marking can be left on the track and it cannot be damaged. Robots that damage the track are disqualified.
- - Robots can use an energy source such as a battery or battery group. Liquid or flammable energy sources cannot be used.
- - Competitors, after the first competition; they can change the tyre wheel or battery on the robots. They cannot make any other changes on the robot. In all physical appearance changes such as changing the robot body, the robot is disqualified.
- - The robot will be disqualified if the square code pasted on the registration desk during the competitions is removed, replaced and the square code is damaged.
- - Robots that do not match the competitor robot photos on the referee table are disqualified.
- - When the electronic circuit elements need to be replaced, the same type of elements can be replaced in the same place. The QR code must not be damaged during the replacement of the elements. Otherwise, the robot is disqualified.
- - The QR code must be affixed to the robot body. It should not be pasted on removable materials. In such cases, the referee disqualifies the robot in case of a problem with the robot.



Ahican in the Footsteps of the Republic, Pursuing Technology in Bursa

Objections made during the competitions due to illuminated marquees, cameras, cameras and lighting around the track will be deemed invalid. Changes can be made to the track dimensions during the construction phase without disturbing the general structure. The Competition Organising Committee has the right to make changes in the manual when it deems necessary.